

MAX IMA

40 | 80 | 120 | 160

**THE MAXIMUM
IN EXHIBITION SYSTEMS**

The background features a dynamic, abstract pattern of light streaks. These streaks originate from the right side and fan out towards the left, creating a sense of motion and depth. The colors range from deep, dark blues to bright, almost white highlights, giving the impression of light trails or data streams. The overall effect is futuristic and energetic.

TIME LESS

INTRO

Classics need not be reinvented. They withstand the test of time. They are revived by the creativity of their users and can be found in ever-changing areas of application. These unpredictable combinations keep you alive. Small adjustments allow for the use of the latest technology. True to the motto: Keep it simple. Therefore the question is not: What comes after the classic Maxima in exhibition construction? Rather: What new applications are we talking about? And what adaptations are necessary for this? Here are a few imaginative answers.

**KEEP
IT
SIMPLE**



CONTENT

MAXIMA	6
Maxima 40	8
Technical Features	10
In Use	12
Maxima 80	16
Technical Features	18
In Use	20
Maxima 120/160	26
Technical Features	28
In Use	30



VERSATILE FLEXIBLE CUSTOMIZED

THE SYSTEM THAT IS OUT OF THE ORDINARY

Maxima. The classic in exhibition construction. With extrusion depths of 40, 80, 120 and 160 mm, they can be used anywhere: from display and retail markets to exhibition stands with an impressive 6 metres in height. In addition to the proven features such as the patented tension lock technology, sustainable construction and quick assembly, there is a



multitude of other functions that equip Maxima for future design concepts. The integration of the latest technology such as LED panels and OCTAlumina light frames as well as additional proof of stand stability provide the necessary creative freedom. Maxima – the timeless exhibition construction system.



LIGHTWEIGHT FILIGREE CONVERTABLE

THE MAXIMUM IN THE RETAIL AND DISPLAY MARKET

Do you need a system that is ideally suited for smaller exhibition stands, displays and the retail sector? That's no problem with Maxima 40. Thanks to its low weight and extrusion depth, it can be used for furniture all the way to individual stand constructions. And up to a construction height of 3 metres: completely covered with fabric and panels, exposed, or in

combination with the OCTAfloor floor system and the OCTAwall 40 wall system. OCTAlumi-
na 40 provides additional bright accents. Get the most out of your products – over and over
again.



TECHNICAL FEATURES

Maxima 40



Light weight



Patented tension lock

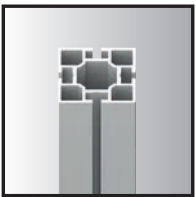

40 mm extrusion depth



Curved extrusions



Panel covering 16 mm



Universal door

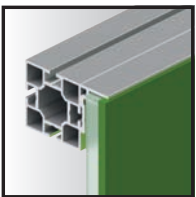

Fabric covering



Accessories (e.g. Wallwasher)

Display, retail, or exhibition? Everything!

Short assembly times and quick change of location. This is precisely where the strengths of Maxima 40 lie. Small, light and versatile, it is suitable for any product and can be easily transported.

Fashion today, food tomorrow.

With Maxima 40 you don't have to do without your corporate design! Our system can be dressed up over and over again. With glass, panels or fabrics. On one or both sides. Quickly adaptable thanks to practical system groove. And all this without any visible extrusions. So that the most important thing is always in the foreground: Your product and your brand presentation.

Show corners and edges – with curves.

Break out of the 90° world: Curved profiles enable new styling and fresh designs. Let your creativity run free and don't hold on to lines. Our variable angle connectors offer additional freedom.

Our system groove. Countless possibilities.

Wallwashers, shelves, magnetic holders and much more – A variety of accessories can be inserted into our system groove. Perfectly coordinated, additional features and articles can be easily added.



IN USE

Maxima 40

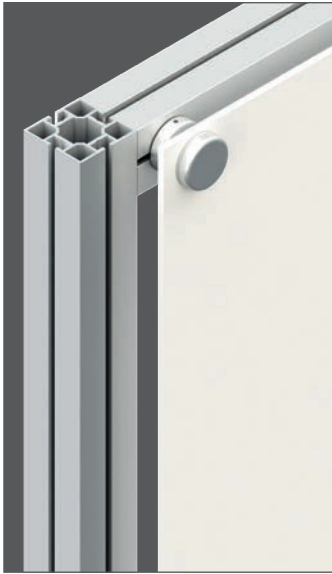

Various glass and panel holders such as M 1392 ensure easy mounting of glass surfaces and panels.

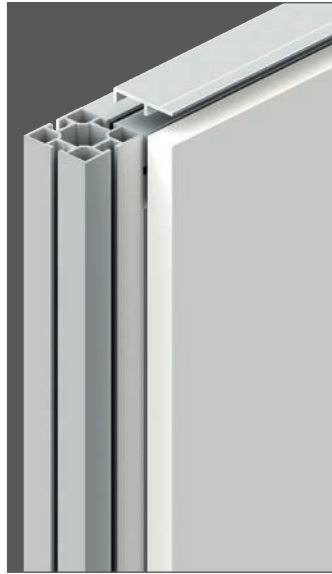

The wall mounting profile M 1562 offers a further possibility to integrate panels, even without drilling holes in the front.



The wallwasher M 1497 illuminates panels evenly from top to bottom – up to a height of 2.5 m.



Customised furniture, according to your ideas and requirements! Exposed or dressed up. Due to the low extrusion depth, the profiles are perfectly suited for **use as product carriers**

– without distracting from the product. And can be **rearranged, combined and adapted** again and again. Coated in your RAL colour on request.



Stand size: 7 × 4.5 × 2.5 m (L × W × H)
 Products: Maxima 40 | OCTAwall 40



The frame system OCTAwall 40 additionally offers the possibility to integrate curved walls and continuous graphics.



With Maxima 40 curved extrusions in different radii are no problem.

IN USE

Maxima 40

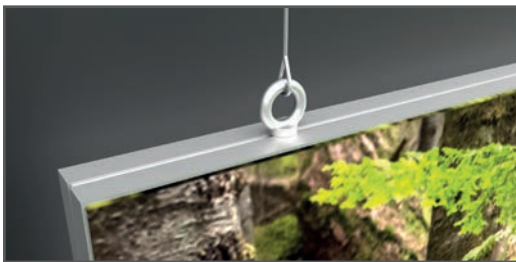

OCTALumina 40 can be suspended as a frame, integrated flush (connector OL 495) or used as a ceiling light.

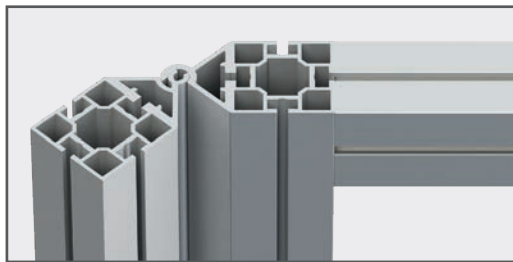

Angles between 90 and 180° can be freely realised with the W 908 hinge profile.



VERSATILE DURABLE DYNAMIC

THE MAXIMUM OF FREEDOM

The optimal system for your exhibition stand: The extrusion depth of 80 mm offers stability for heights up to 6 metres – free-standing, or as a complete room solution including door element. Can be completely covered with fabric and panelling. Additional attention is drawn

MAXIMA 80



to your advertising message by integrated LED panels and OCTAlumina light frames. Some installation types are even supplied with proof of stability. As versatile and combinable as no other system. In short: With Maxima 80, you are already ready for the future.



TECHNICAL FEATURES

Maxima 80



Up to 6 m height



Patented tension lock

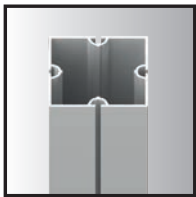

80 mm extrusion depth

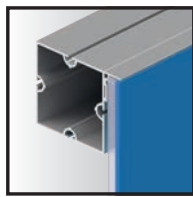

Fabric covering



Panel covering 16 mm



Universal door

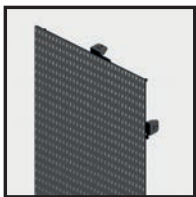

Mounting of LED panels

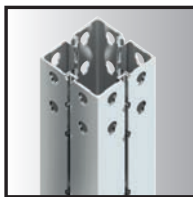

OCTAuniversal upright



Proof of stand stability

Perfect for exhibitions? Yes. But not just exhibitions!

Versatile. Stable. Adaptable. Everything you need at an exhibition. Reusable and light due to the aluminium material. Perfectly combinable with other OCTANORM systems. A system with added value, which is suitable for exhibitions of any kind. With Maxima 80 you stay flexible.

From floor to ceiling.

Whether visible or not, the Maxima 80 extrusions always achieve top performance. Besides the cladding with panels or fabrics, the main advantage of the system is its compatibility with other systems such as OCTALumina 80 light frames, OCTArig ceiling construction or also OCTAuniversal as substructure. Furthermore, the proof of stand stability is already integrated for some OCTAuniversal kits – efficient and cost-saving.

Videos instead of pictures: LED Panels.

It is hard to imagine exhibition stands without LED panels. But this does not require a complicated substructure. The LED panels are simply hooked into the keyholes of the OCTAuniversal upright using our special brackets. This way you can always integrate the latest panels from the manufacturer you trust. Highest quality. Highest safety. Without restrictions.

Setting light in motion.

OCTALumina dynamic light brings your fabric motifs to life. Individually controllable LEDs can be used to highlight or dim specific areas. Underline your advertising message and change simple surfaces with exciting RGB colour changes. The same motif. A completely different effect.



Stand size: 7 × 9 × 4 m (L × W × H)
 Products: Maxima 80 | OCTAlumina 80 | OCTAfloor



With the mounting set
 W 835, OCTAlumina 80 light
 frames are integrated flush
 into the system.

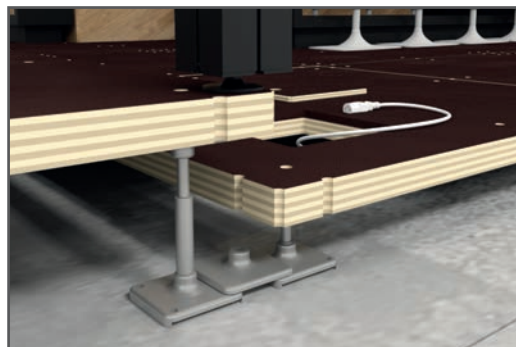

The double floor system
 OCTAfloor allows for the
 efficient laying of pipes
 and cables as well as
 platform construction.

IN USE

Maxima 80



Stand size: 14 x 8 x 5,5 m (L x W x H)
Products: Maxima 80 | OCTAwall custom | OCTAfloor

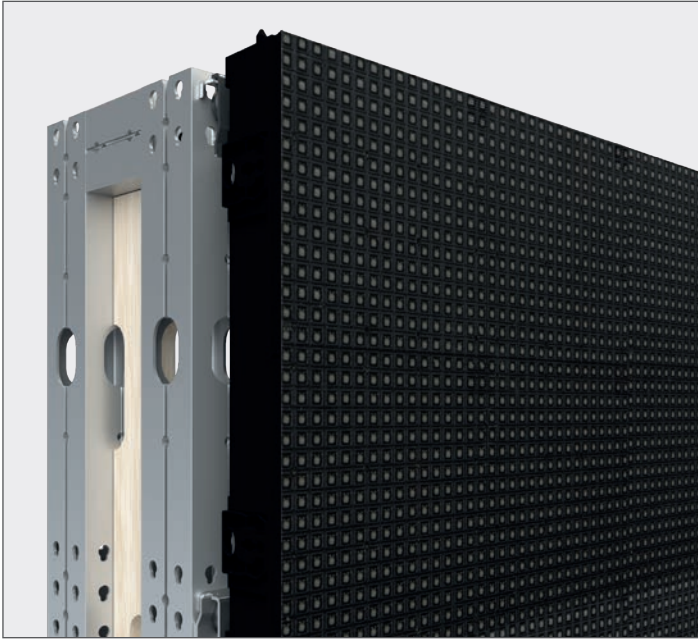

OCTAuniversal upright: various modules are simply hooked into the keyholes on site.

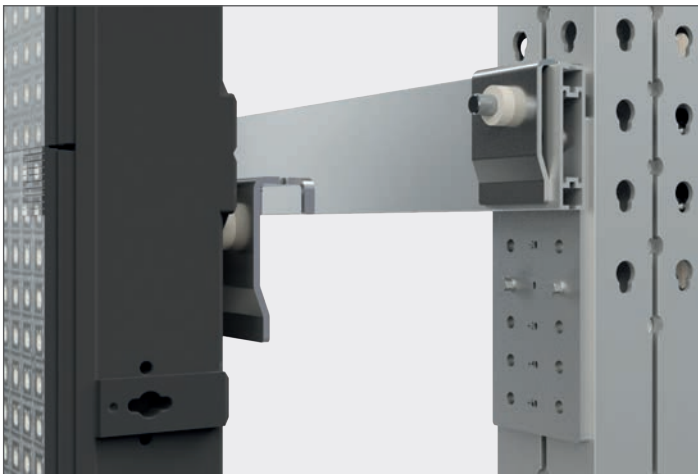

The adapters can be mounted onto LED panels of different manufacturers.

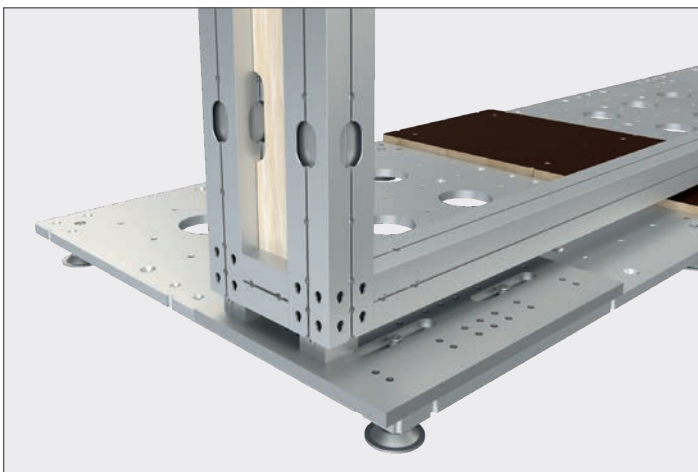

Floor plates installed in the double floor enable free-standing walls up to 6 metres high – right on the edge of the stand.

IN USE

Maxima 80





Expand your stand space by adding another level with our double-decker system OCTAmax 350.



Exciting 3D effects with OCTAlumina plus: 2 layers of fabric allow for even more depth and attraction!

IN USE

Maxima 80

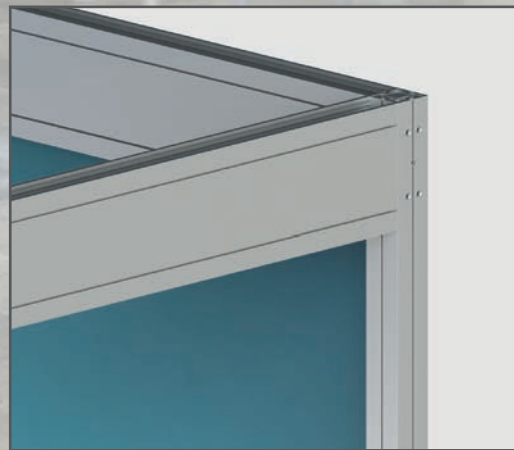

Maximum overall height: 6 metres. The ceiling construction OCTArig can also be used on uprights.

Stand size: 15 × 13 × 6 m (L × W × H)
Products: Maxima 80 | OCTAlumina (plus) | OCTArig | OCTAmax 350

STYLISH SLICK SUPPORTABLE

STABILITY THAT YOU CAN SEE

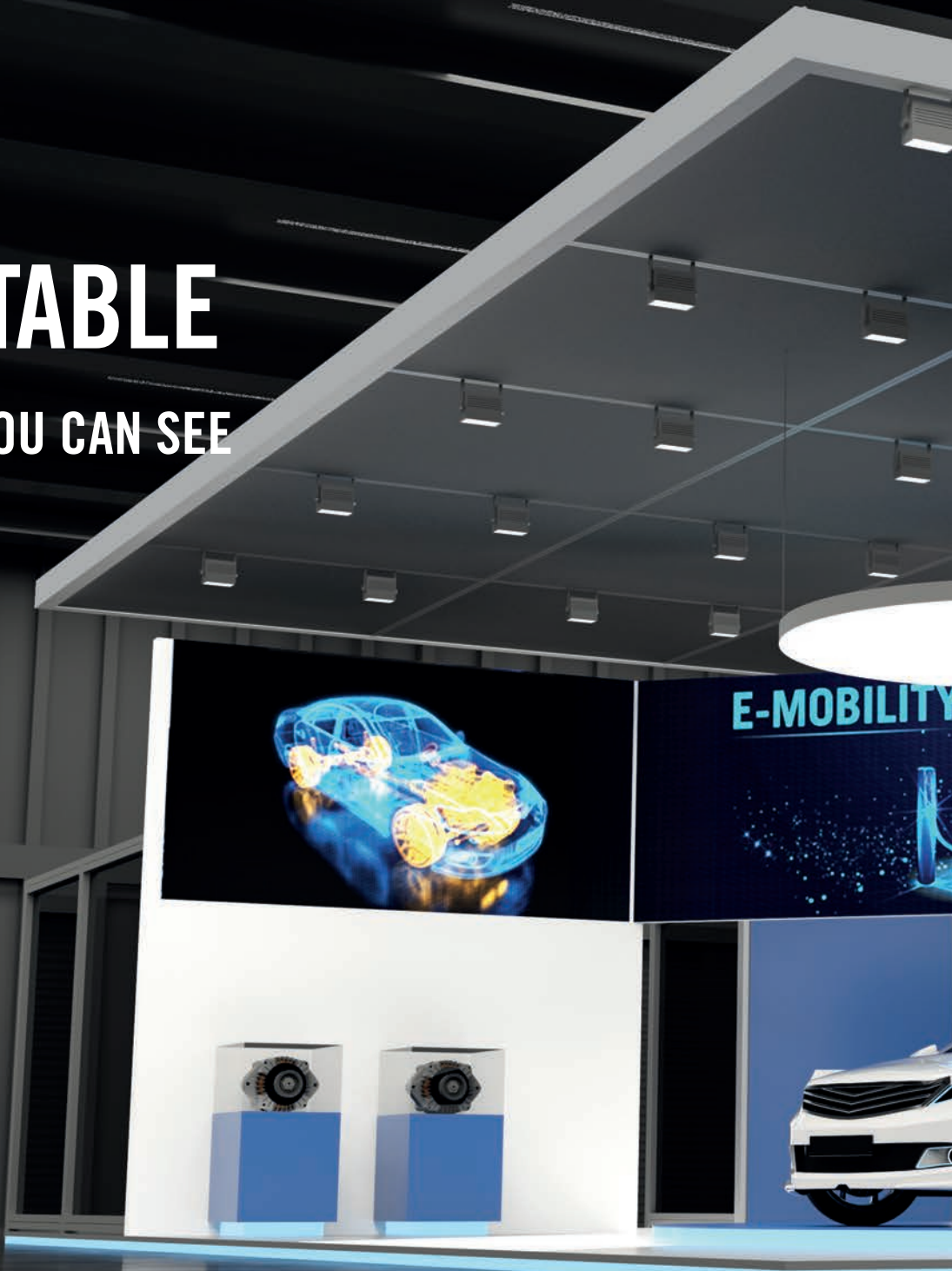

Extrusions as a design element? With their slick and balanced shape, Maxima 120 and 160 are particularly suitable for designs that play with cladding and exposed extrusions. Can be installed up to 6 meters high, the system promises to stand out from the crowd – and thanks to special coating also in your desired colour.





TECHNICAL FEATURES

Maxima 120 | 160



Up to 6 m height



Patented tension lock

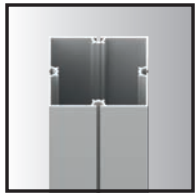

120 mm extrusion depth

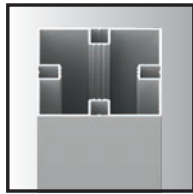

160 mm extrusion depth

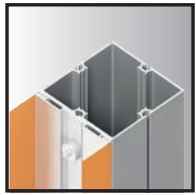

Fabric covering



Universal door

Big, bigger, Maxima.

Visible constructions and extrusions. Stand designs that require a lot of freedom. With an extrusion depth of 120 and 160 mm, this system focusses on its columnar appearance. Large areas bridge the high span width in a simple way – without any further support. And so that the system matches your brand image, the extrusions can be coated in your desired colour: Maxima 120 or 160 as a supporting design element.

Exposed. And dressable.

Just like the rest of the Maxima family, the system can be clad with panels and fabrics. On one or both sides. Stably and securely mounted – ready to spread your exhibition message. The carrier system OCTArig and the double-decker system OCTAmax 350 create additional space at your stand space. Further eye-catchers can also be placed in combination with OCTAlumina 120. Leave nothing to chance and guide the attention of your visitors!



For additional stability and load capacity, securing plates (M 1164) and node stiffeners (M 1139) can be fitted.

**WHETHER TEMPORARY
OR PERMANENT:
MAXIMA IS TIMELESS
THANKS TO ITS SLICK
DESIGN.**

IN USE

Maxima 120 | 160



Stand size: 6 × 6,5 × 6 m (L × W × H)
Products: Maxima 120 | OCTAfloor



Expand your stand space by adding another level with our double-decker system OCTAmax 350.



Glass panels can be placed in front or inserted into the system groove using the E 420 glass retaining profile.



IN USE

Maxima 120 | 160



Stand size: 15 × 8 × 6 m (L × W × H)
Products: Maxima 120 | OCTAmax 350 | OCTAfloor

EXHIBITION SYSTEMS
PROJECT SOLUTIONS
PRESENTATION
INTERIOR DESIGN
CLEANROOM SYSTEMS

**OCTANORM® Germany
Head Office**

Raiffeisenstraße 39
70794 Filderstadt
T. +49 711 77003-0
F. +49 711 77003-53
info@octanorm.de
www.octanorm.com

EUROPE

OCTANORM® Nordic
T. +46 8 621 6500
www.octanorm.se

OCTANORM® Polska
T. +48 22 773 0350
www.octanorm.pl

OCTANORM® Belgium
T. +32 475 35 60 76
www.octanorm.be

OCTANORM® France
T. +33 6 79 11 32 05
www.octanorm.fr

OCTANORM® UK
T. +44 20 85 45 2945
www.octanorm.co.uk

OCTANORM® Espana
T. +34 930 019 424
www.octanorm.es

OCTANORM® Hellas
T. +30 2310 79 6521
www.octanorm.gr

OCTANORM® Italia
T. +39 031 2269715
www.octsystem.it

OCTANORM® Adria
T. +386 590 56301
www.octanormadria.com

AFRICA

OCTANORM® South Africa
T. +27 11 433 2010
www.octanorm.co.za

AMERICA

OCTANORM® North America
T. +1 770 7 32 1520
www.octanormna.com

OCTANORM® México
T. +52 55 5804 6325
www.octanorm.com.mx

ASIA

OCTANORM® China
T. +86 512 6283 3336
www.octanorm.cn

OCTANORM® Japan
T. +81 45 511 8144
www.octanorm.co.jp

AUSTRALIA

OCTANORM® Australia
T. +61 3 7017 2753
www.octanorm.com.au

MIDDLE EAST

OCTANORM® Emirates
T. +971 4 340 6888
www.octanormemirates.net